

Roadranger®

Eaton® Fuller® Automated Transmissions

CE 18-Speed Model



One Great Drivetrain from Two Great Companies

Driver Instructions TRDR-0011 April 2003

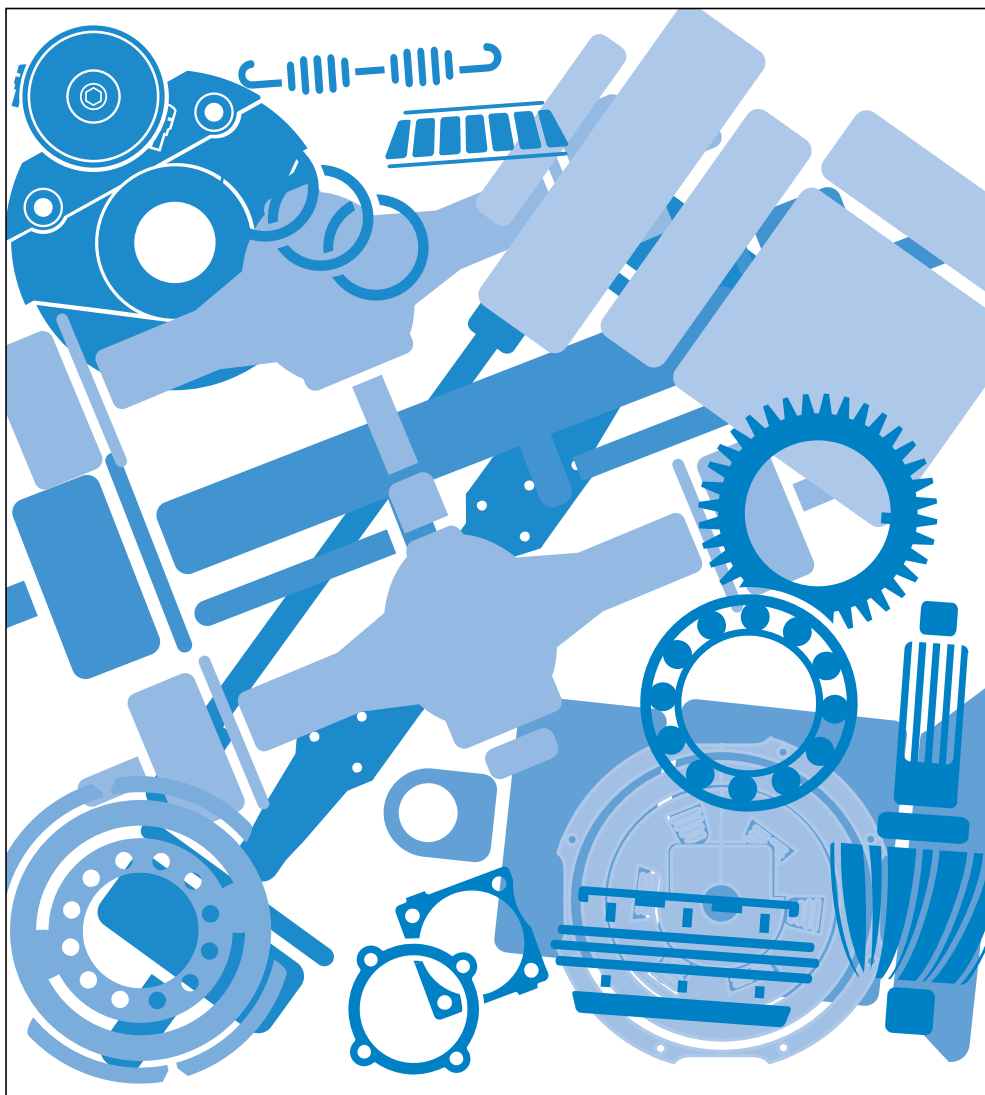

For the most current information, visit the Roadranger web site at www.roadranger.com

Warnings

Warnings and Precautions



Read the entire driver instructions before operating this transmission.

Set the parking brakes before starting a vehicle, always be seated in the driver's seat, move the shift level to neutral, and depress the master clutch.

If engine cranks in any gear other than neutral or without the master clutch depressed, service your vehicle neutral safety start circuit immediately.

Before working on a vehicle or when leaving the cab with the engine running, place the transmission in neutral and set the parking brakes.

Do not release the parking brake or attempt to select a gear until the air pressure is at the correct level.

When parking the vehicle or leaving the cab, always place the shift lever in neutral and set the parking brakes.

If your vehicle is equipped with a remote throttle, before operation, the transmission must be in neutral. See the "Remote Throttle Operation" Section.

TOWING: To avoid damage to the transmission during towing, disconnect the driveline.

Table of Contents

Reference Numbers	
Tag Information	1
Model Designations	
Nomenclature.....	2
Shift Lever Positions	
Shift Positions.....	3
Shift Controls	
Roadranger Valve-A-5013	4
General Information	
18-Speed Operation	5
Transmission Features	
Features	7
Operation	
Driving Operation	8
Lubrication	
Proper Lubrication	13
Preventive Maintenance	
Maintenance Checks	19

Reference Numbers

Tag Information

The blank spaces provided below are for recording transmission identification data and part numbers of maintenance items. Have these reference numbers handy when ordering replacement parts or requesting service information:

Transmission Model _____

Transmission Serial Number _____

Filter Part Numbers _____

Oil Filter Kit _____

Air Filter Element _____

Oil Sump Pan Gasket _____

Every effort has been made to ensure the accuracy of all information in this brochure. However, Eaton Corporation makes no expressed or implied warranty or representation based on the enclosed information. Any errors or omissions may be reported to Technical Service, Eaton Corporation, P.O. Box 4013, Kalamazoo, Michigan 49003-4013.

Model Designations

Nomenclature

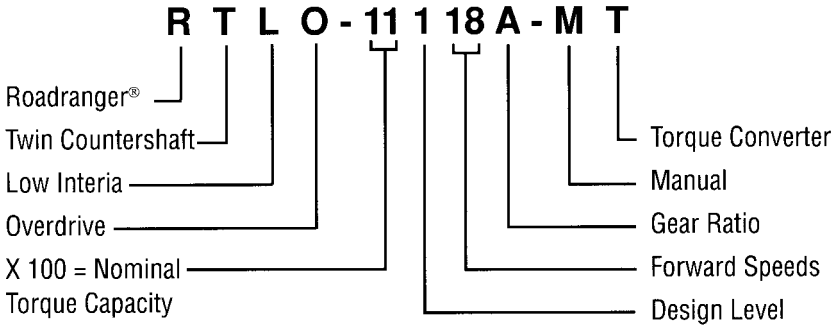

IMPORTANT: All Eaton® Fuller® Transmissions are identified by the model and serial number. This information is stamped on the transmission identification tag and affixed to the case.

DO NOT REMOVE OR DESTROY THE TRANSMISSION IDENTIFICATION TAG.

Shift Lever Positions

Shift Positions

Shift LO-1-2-3-4 in LO Range

Range shift...

Shift 5-6-7-8 in HI Range

Direct—LO and HI Range

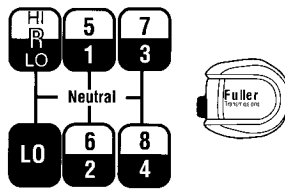

While in LO range...

Ratios can be split by moving the splitter button to the overdrive (forward) position.

Overdrive—LO Range

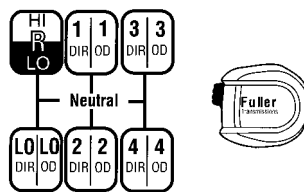

While in HI Range...

Ratios can be split by moving the splitter button to the overdrive (forward) position.

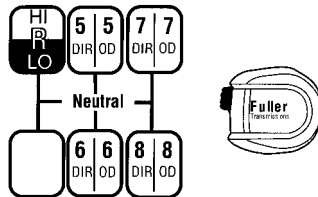

Shift Controls

Roadranger Valve A-5013

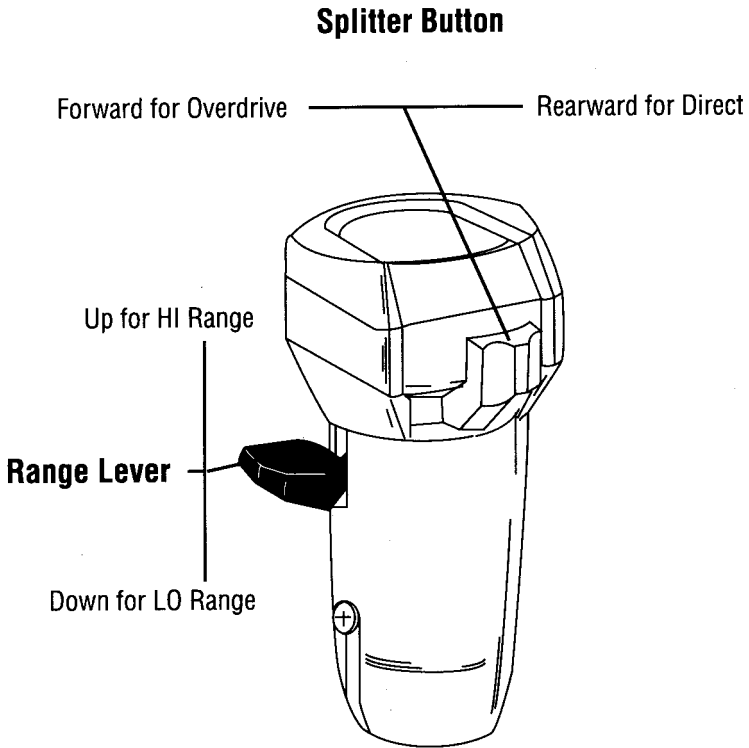

General Information

18-speed Operation

The "MT" 18-speed is an Eaton® Fuller® 18-speed Roadranger® transmission that uses a converter to multiply torque.

The 18-speed transmission has eighteen forward speeds and four reverse, consisting of a five-speed front section and a 2 x 2 speed auxiliary section. The auxiliary section contains LO and HI range ratios, plus an overdrive splitter gear.

One front section ratio (LO) is used only as a starting ratio; it is never used when the transmission is in HI range. The other front section ratios are used once in LO range and once again in HI range. Each of the 5 ratios (LO-1-2-3-4) in LO range and each of the 4 ratios (5-6-7-8) in HI range can be split with the overdrive splitter gear.

The converter has two modes of operation, converter mode and lock-up mode. When the dash-mounted transmission indicator light is "on", this indicates converter mode. This would normally occur at lower engine speeds (RPM's). In this mode the converter is multiplying engine torque to the transmission.

When the light is "off", the converter is in lock-up mode. This mode normally occurs at higher engine speeds (RPM's). In this mode, the converter is bypassed and engine torque is routed directly to the transmission without being multiplied.

If the light stays "on" for extended periods of time, the driver needs to select a lower gear. If the light does not go "off", there may be a system problem. If this occurs, transmission service may be required.

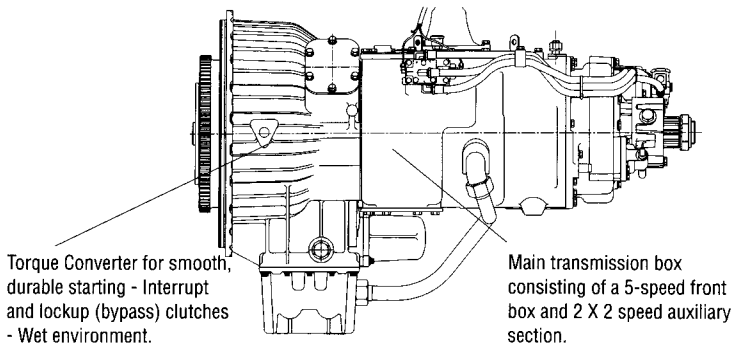

Features

Range Shift

The range lever selects LO or HI range. It is used once during an upshift sequence and once during a downshift sequence.

Split Shift

When in LO or HI range the ratios can be split by using the splitter button. The rearward (direct) position provides for the LO through 8th speed direct gear ratios. The forward (overdrive) position is used to split any of the LO or HI range gear ratios. This is how to obtain eighteen progressive ratios.

Preselect

IMPORTANT: Always preselect all range or splitter shifts when upshifting or downshifting. Preselection requires that the range lever or splitter button is moved to the needed position before starting the shift.

Preselected range shifts are completed automatically as the lever is moved through neutral and into the next gear. Preselected split shifts are completed automatically as torque is released from the transmission. Preselecting all range and splitter shifts prevents damage to the transmission and provides for smoother shifts.

Inertia Brake

This transmission is equipped with an inertia brake that is activated by depressing the clutch pedal to the floor. The brake should always be used for initial gear engagement or engagement of the transmission driven power take-off.

If, when attempting to make initial engagement or engagement of P.T.O., excessive clashing occurs, check for proper air pressure. The master clutch may need adjustment, or the inertia brake may need servicing.

During cold weather operation, it may be necessary to depress and release the clutch pedal more than once if clashing occurs.

Operation

Driving Operation

Driving Tips

- Always select an initial starting gear that provides sufficient reduction for the load and terrain.
- Always use normal double-clutching procedures when making lever shifts.
- Never slam or jerk the shift lever to complete gear engagements.
- Never coast with the gearshift lever in the neutral position.
- Never move the shift lever to the LO speed gear position while operating in HI range.
- Never move the range lever or the splitter button with the gear shift lever in neutral while the vehicle is moving.
- Never make a range shift while moving in reverse.
- Never downshift at too high of a road speed.
- Do not skip shift across the range, up or down.
- In most cases, depending on the engine and axle ratios, you can save valuable fuel by operating the vehicle at less than governed RPM while cruising in 8th overdrive.

Double-Clutching Procedure

When ready to make a shift:

1. Depress pedal to disengage clutch.
2. Move the gear shift lever to neutral.
3. Release pedal to engage clutch.
 - a. Upshifts - Decelerate engine until engine RPM and road speed match.
 - b. Downshifts - Accelerate engine until engine RPM and road speed match.
4. Quickly depress pedal to disengage clutch and move gear shift lever to next gear speed position.
5. Release pedal to engage clutch.

*By engaging the clutch with the lever in the neutral position, the operator is able to control the mainshaft gear RPM since it is regulated by engine RPM. This procedure helps the operator match the mainshaft with the driveline.

Initial Start-Up

WARNING

Warning: Set the parking brakes before starting a vehicle, always be seated in the driver's seat, move the shift lever to neutral, and depress the master clutch.

1. Make sure the shift lever is in neutral and the parking brakes are set.
2. Turn on the key switch to start the engine.
3. Allow the vehicle air pressure to build to the correct level. Refer to your "Operator and Service Manual" supplied with the vehicle.
4. Apply the service brakes.
5. Depress the clutch pedal to the floor.
6. Move the shift lever to the desired initial gear.
7. Release the parking brakes on the vehicle.
8. Slowly release the clutch pedal and apply the accelerator.

In the following instructions, it is assumed that the driver is familiar with operating heavy-duty trucks and tractors, and can coordinate the movement of the shift lever and clutch pedal to make smooth gear engagements while upshifting or downshifting. Always double-clutch when making lever shifts. Always single clutch split shifts.

CAUTION

CAUTION: Never move the splitter button or the range lever with the shift lever in neutral while the vehicle is moving.

Upshifting

Upshift from direct to overdrive in the same gear shift lever position

1. Move the splitter button into the forward (overdrive) position.

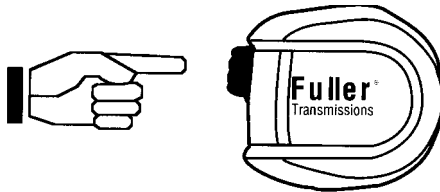

Operation

2. Then IMMEDIATELY release the accelerator, depress the clutch pedal once to break torque, release the pedal to engage the clutch, and accelerate the vehicle. The transmission will shift from direct to overdrive when synchronous is reached.



Release Accelerator . . . Single-Clutch . . . and Accelerate.

EXAMPLE: To shift from 1st direct to 1st overdrive.

Upshift from overdrive to direct changing shift lever position.

1. Move the splitter button into the rearward (direct) position.

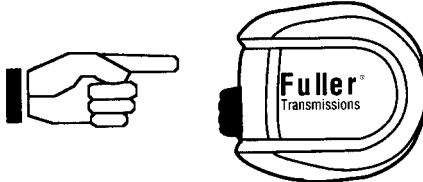

2. Move the shift lever, double-clutching, to the next desired gear position.

EXAMPLE: To shift from 3rd overdrive to 4th direct.

Downshifting

Downshift overdrive to direct in the same gear shift lever position

1. Move the splitter button into the rearward (direct) position.

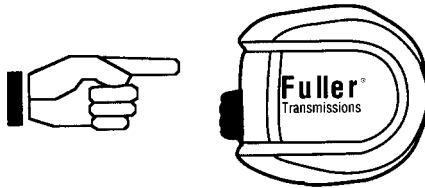

2. Then IMMEDIATELY release the accelerator, depress the clutch pedal once to break torque, release the pedal to engage the clutch, and accelerate the vehicle. The transmission will shift from overdrive to direct when synchronous is reached.



Release Accelerator . . . Single-Clutch . . . and Accelerate.

Example: To shift from 7th overdrive to 7th direct.

Downshift from direct to overdrive changing shift lever position

1. Move the splitter button into the forward (overdrive) position.

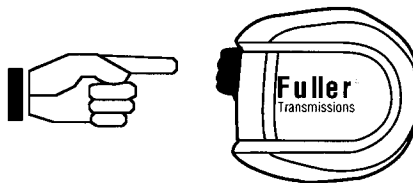

2. Move the shift lever, double-clutching, to the next desired gear position.
EXAMPLE: To shift from 6th direct to 5th overdrive.

Operation

Remote Throttle

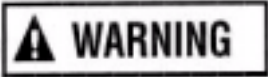

Warning: BEFORE OPERATING THE REMOTE THROTTLE, MAKE SURE THE TRANSMISSION IS IN NEUTRAL.

To Make Sure the Transmission in Neutral:

1. Move the shift lever to the neutral position.
2. Move the shift lever side to side in the neutral position to insure neutral.
3. Push the shift lever to the far right.
4. Release the clutch.
5. Step on the accelerator, raise the engine RPM to the desired operating RPM and verify the vehicle does not move. If the vehicle moves, repeat Steps 1 through 5.
6. Follow the remote throttle operating procedure supplied with the vehicle.

Transmission Cold Weather Warm-up

1. Make sure the parking brakes are set and the gear selector is in neutral.
2. Start the engine.
3. Maintain at idle until the engine reaches operating temperatures.
4. Allow the air pressure to reach 90 PSI.
5. Select desired gear and proceed.

Proper Lubrication

The Key to Long Transmission Life

Proper lubrication procedures are the key to a good all-around maintenance program. If the oil is not doing its job, or if the oil level is ignored, all the maintenance procedures in the world are not going to keep the transmission running or assure long transmission life.

Eaton® Fuller® Transmissions are designed so that the internal parts operate in an oil bath circulated by the motion of the gears and shafts.

Thus, all parts are amply lubricated if these procedures are closely followed:

1. Maintain oil level. Inspect regularly.
2. Change oil and filters regularly.
 - Use the correct grade and type of oil.
 - Buy oil from a reputable dealer.

Note: Additives and friction modifiers are NOT recommended for use in Eaton Fuller Transmissions.

For additional lubrication information, see TCMT-0021.

Lubrication

Operating Temperatures

Transmissions must not be operated at temperatures above 250°F [120°C]. Operation at temperatures above 250°F [120°C] causes loaded gear tooth temperatures to exceed 350°F [177°C] which will ultimately destroy the heat treatment of the gears. If the elevated temperature is associated with an unusual operating condition that will recur, a cooler should be added, or the capacity of the existing cooling system increased.

The following conditions in any combination can cause operating temperatures over 250°F [121°C].

- Operating consistently at slower speeds
- High ambient temperatures
- Restricted air flow around transmission
- High horsepower
- Use of engine retarder

Transmission coolers must be used to reduce operating temperatures when the above conditions are encountered.

On vehicles equipped with two transmission oil temperatures gauges, one gauge (required) senses torque converter oil, while the other gauge (optional) reads oil temperature from the transmission sump. The sump temperature represents oil that has circulated through the cooler. This temperature is normally below 225°F; however, intermittent sump temperatures to 250°F do not harm the transmission.

Transmission Operating Angles

If the transmission operating angle is more than 12 degrees, improper lubrication can occur. A special kit may be required for sustained operation on grades greater than 12 degrees.

Lubrication Change and Inspection	
HIGHWAY USE	
First 1,000 to 1,500 miles	Flush hydraulic system and change transmission oil filter on new units.
Every 2,500 miles	Inspect lubrication levels. Check for leaks.
Every 50,000 miles or 1 year	Change transmission lubricant and filter.
OFF-HIGHWAY USE	
First 30 hours	Flush hydraulic system and change transmission oil filter on new units.
Every 40 hours	Inspect lubrication level. Check for leaks.
Every 500 hours	Change transmission lubricant and filter where severe dirt conditions exist.
Every 1,000 hours	Change transmission lubricant and filter. (Normal off-highway use.)

Lubrication

Oil Dipstick



WARNING: Before working on a vehicle, place the transmission in neutral, set the parking brakes, and block the wheels.

Maintaining Oil Level

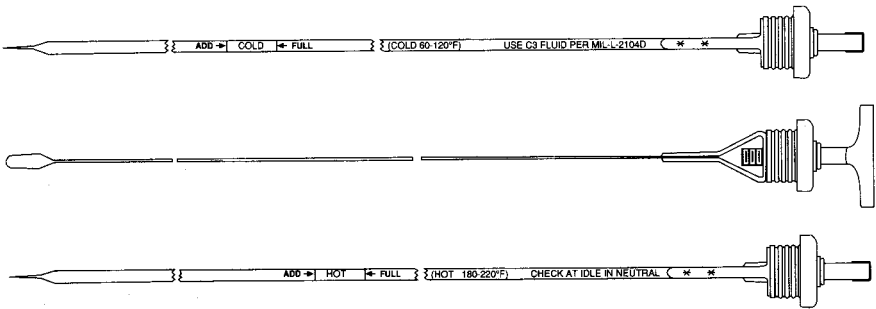

Different Views of the Oil Dipstick

Make sure oil is within dipstick marks for the corresponding oil temperature. Oil should be checked at idle speed in the neutral position using the corresponding temperature band. Cold checks can be performed when the oil temperature is 60-120°F. The oil level should be within the dipstick "cold" band. Additional checks can be made with the transmission at operating temperature by using the "hot" band on the opposite side of the dipstick. The "hot" band temperature range is 180-220°F.

Lubrication Change

Draining Oil

Drain transmission while oil is warm. To drain oil, remove the two (2) drain plugs at the case bottom and oil pan. Clean the drain plugs and flush the cooler circuit before re-installing.

Refilling

The operational level should always be within the appropriate temperature bands on the dipstick. The exact amount of oil depends on the transmission inclination and model. Insufficient oil damages the pump and other components, and can affect the function and reduce the life of the transmission.

DO NOT OVERFILL! This causes overheating and loss of fuel economy.

When adding oil, types and brands of oil should not be mixed because of possible incompatibility.

Use clean oil and clean containers when filling transmission. Containers that have been used for anti-freeze or water should not be used for transmission oil.

1. Remove the dipstick and slowly add seven (7) gallons of the prescribed oil through the fill tube.
2. Place the transmission in neutral position and apply the parking brakes. Start the engine and let it idle for five (5) minutes, (this allows oil to fill the converter, main case, and cooling system). Add oil as needed to obtain a level at the proper temperature range. Total oil quantity needed at this time should be approximately 10 gallons; this varies depending on the cooling system.
3. Increase the engine idle slowly to 1500 RPM for five (5) minutes. Now recheck the oil level at normal idle speed in neutral, again adding oil to obtain a level at the proper temperature range.
4. Replace the dipstick and tighten securely.

Lubrication

Hydraulic System Flush

A complete hydraulic circuit flush should be completed when:

- First 1,000 to 1,500 miles for highway use or 30 hours for off-highway use.
- A catastrophic failure has occurred.

Assumption: The transmission is at ambient (65°F +/-20) temperature.

1. Begin draining the transmission from the two drain locations.
 - a. At the transmission main case drain plug (rear at bottom).
 - b. At the converter housing oil pan drain plug.
2. Disconnect the transmission cooler supply line between the transmission outlet and the oil cooler (not between the cooler and the transmission oil pan).
3. With 80 PSI clean, dry air from a hose and nozzle, use a rubber stopper or clean rag to seal the air hose to the converter outlet hose.
4. Apply air to the converter outlet for approximately two minutes to backflush oil into the transmission oil pan.
5. Disconnect oil lines and dipstick tube from the sump pan.
6. Remove and clean the sump pan.
7. Remove the oil strainer/tube from the torque converter housing.
8. Remove the oil strainer from the tube and clean.
9. Assemble the oil strainer on the tube.
10. Position a new gasket and install the oil strainer/tube.



CAUTION: Use the proper tool to tighten the retaining capscrews on the sump pan, damage can occur.

11. Install the sump pan. Tighten the retaining capscrews to 14 to 20 Lb. ft. of torque.
12. Connect the oil lines and dipstick tube.
13. Connect the hose between the transmission and cooler. Tighten to vehicle manufacturer's specification.
14. Install the transmission converter housing oil pan drain plug and tighten to 14 to 20 Lb. ft. of torque.
15. Install the transmission main case drain plug (rear at bottom) and tighten to 45 to 50 Lb. ft. of torque.

Lubrication

16. Remove the transmission dipstick and slowly pour 7 gallons of the prescribed oil into the transmission.
17. Apply the vehicle parking brakes and place the transmission lever in neutral. Start the engine and let it idle for 5 minutes. Check the dipstick periodically while the engine is idling, adding oil as needed, to obtain a level that is in the cold band on the dipstick. Total quantity added at this time should be approximately 10 gallons.
18. With the transmission still in neutral, increase the engine idle speed to 1500 RPM and retain at this speed for 5 minutes. Now check the oil level at normal engine idle speed in neutral, again adding oil as required for a level 1 ½" below the "add-hot" mark on the dipstick. Total oil quantity added at this time should be approximately 11 gallons.

Transmission temperature

180 to 220°F - Oil level between the "add-hot" and "full-hot" marks.

Below 100°F - Oil level at the cold fill mark.

Transmission Oil Filter Change

Transmission oil must be drained before proceeding.

1. Remove the retaining capscrews.
2. Remove the filter housing.
3. Replace the oil filter and housing O-ring gasket.
4. Position the filter housing on the transmission.
5. Install the capscrews and tighten to 26 to 32 Lb. ft. of torque.

Preventative Maintenance

Maintenance Checks

Note: Item numbers refer to the illustration.

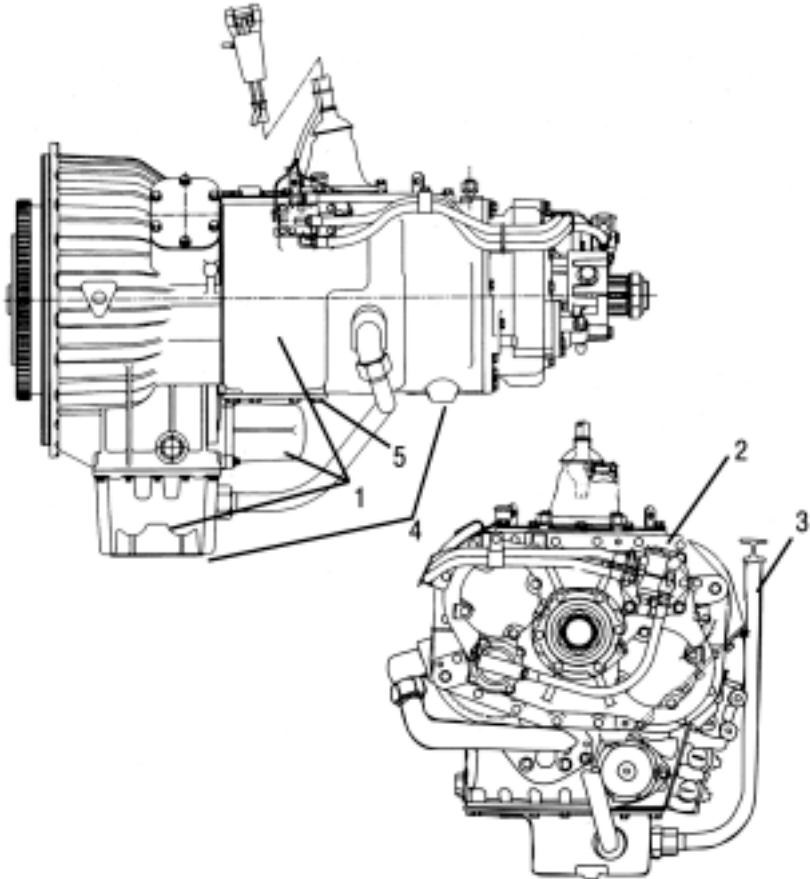

Preventative Maintenance

1. Lubricant and Filter

- Change at specified service intervals.
- Use only the types and grades recommended (See TCMT-0021).
- Check lubrication lines and cooling circuit for leaks.
- Use only genuine Eaton® Fuller® filter elements, when servicing the filter.

2. Air System

- Annually replace the filter regulator element. If excessive contamination is present, service the vehicle air/dryer system. The "MT" 18-speed requires clean, dry air for proper operation. Check vehicle air dryer system regularly for proper operation.

3. Dipstick

- Monitor oil level.
- Add oil if necessary.
- Tighten dipstick securely.

4. Drain Plugs

- Tighten the drain plugs securely. Tighten the main case drain plug to 45-50 Lb. ft. of torque. Tighten oil pan plugs to 14-20 Lb. ft. of torque.

5. Capscrews and Gaskets

- Check all capscrews, especially those on the PTO covers and rear bearing covers for looseness which can cause oil leakage. Tighten capscrews to 35-45 Lb. ft. of torque.
- Check PTO opening, oil sump pan/strainer, and rear bearing covers for oil leakage due to faulty gaskets.

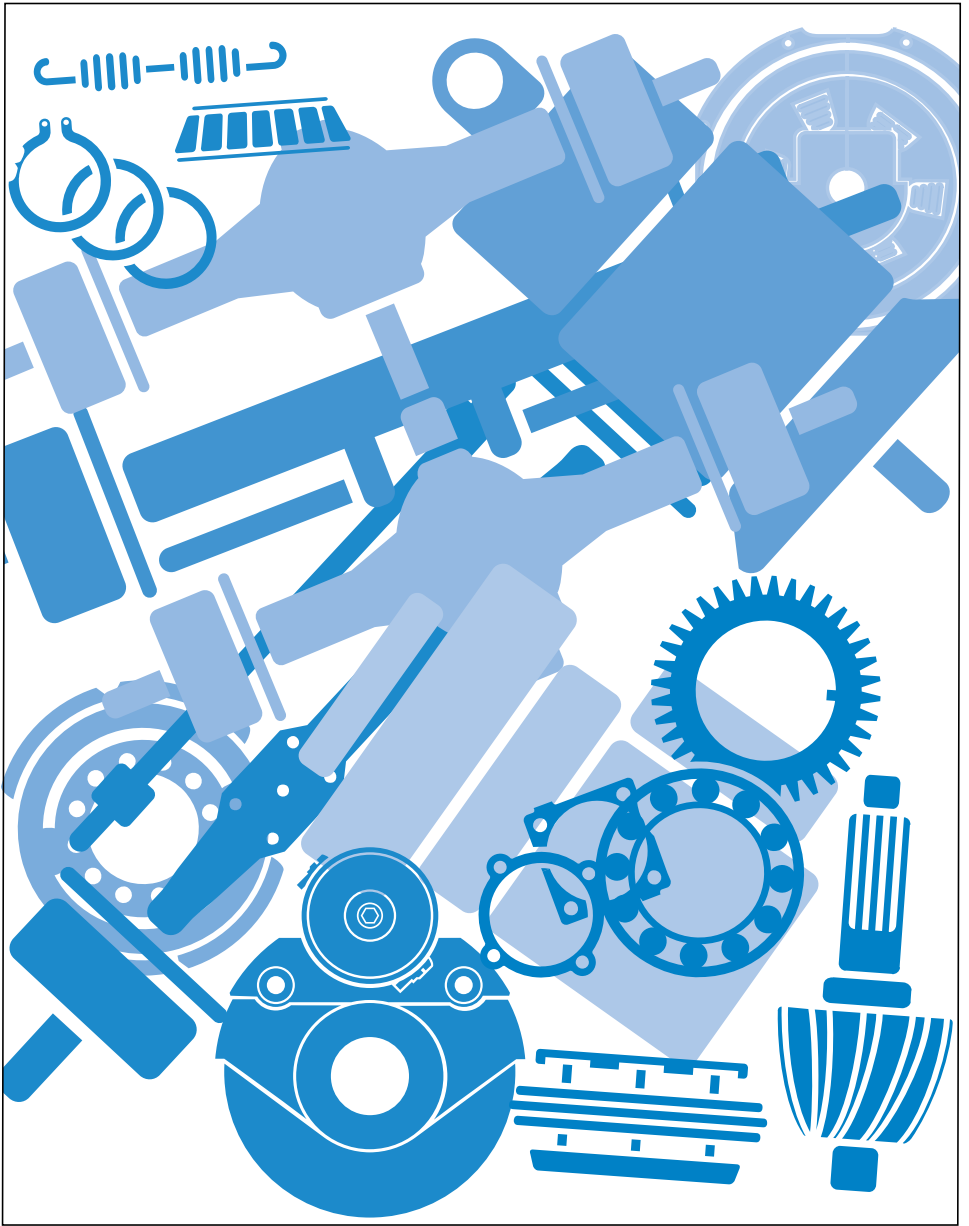

Copyright Eaton and Dana Corporation, 2002. EATON AND DANA CORPORATION hereby grants its customers, vendors, or distributors permission to freely copy, reproduce and/or distribute this document in printed format. THIS INFORMATION IS NOT INTENDED FOR SALE OR RE-SALE, AND THIS NOTICE MUST REMAIN ON ALL COPIES.



National Institute for
**AUTOMOTIVE
SERVICE
EXCELLENCE**

Roadranger

MORE TIME ON THE ROAD

The Roadranger® System is an unbeatable combination of the best products from Eaton and Dana – partnering to provide you the most advanced, most trouble-free drivetrain in the industry. And it's backed by the Roadrangers – the most experienced, most expert, most accessible drivetrain consultants in the business.

For spec'ing or service assistance, call 1-800-826-HELP (4357) 24 hours a day, 7 days a week, (Mexico: 01-800-826-HELP (4357)) for more time on the road. Or visit our web site at www.roadranger.com.



EATON

One Great Drivetrain from Two Great Companies

TRDR-0011
04/03 PDF
Printed in USA